

2J4884PGF

(Alpha Micro Part No. AMC2J4884PGF)

5G NR and GPS/GLONASS adhesive mount antenna

Features

- **Cable 1: 5G NR**
 - 617 – 960MHz
 - 1427 – 2690MHz
 - 3300 – 5000MHz
 - 5150 – 5925MHz
- **Cable 2: GPS/GLONASS/QZSS/Galileo**
 - 1575 – 1606MHz
- Adhesive mount
- Ground plane independent
- Certificates: IP67/IP69
- Dimensions: 83 x 35 x 13.3mm
- Customizable cables and connectors



1. Antenna and Electrical Specifications

Parameters	5G NR Antenna			
Technologies	5G, 4G, 3G, 2G			
Standards	5G NR/4G LTE/FirstNet/CBRS/LPWA/CAT-X/Cat-Mx/CAT-NBx/NB-IoT/3G/2G			
Frequency (MHz)	617 - 960	1427 - 2690	3300 -5000	5150 - 5925
Band (MHz)	600, 700, 850, 900	1500, 1600, 1700, 1800, 1900, 2000, 2100, 2300, 2500, 2600	3300, 3500, 3600, 3700, 4500	5200, 5500, 5800
5G NR Bands	n5, n8, n12, n20, n28, n71, n81, n83	n1, n2, n3, n7, n25, n34, n38, n40, n41, n50, n51, n66, n70, n74, n75, n76, n80, n84, n86	n77, n78, n79	
4G LTE Bands	B5, B6, B8, B12, B13, B14, B17, B18, B19, B20, B26, B27, B28, B29, B44, B67, B68, B71, B85	B1, B2, B3, B4, B7, B9, B10, B11, B21, B23, B24, B25, B30, B32, B33, B34, B35, B36, B37, B38, B39, B40, B41, B45, B50, B51, B65, B66, B69, B70, B74, B75, B76	B22, B42, 43, B48, B49, B52	B46, B47, B252, B255
3G CELL Bands	B5, B6, B8, B12, B13, B14, B19, B20, B26	B1, B2, B3, B4, B7, B9, B10, B11, B21, B25, B32, B33, B34, B35, B36, B37, B38, B39, B40	B22	
2G CELL Bands	710, 750, 810T, 850, 900P, 900E, 900R	1800DCS, 1900PCS		
CDMA CELL Bands	BC0, BC2, BC3, BC7, BC9, BC10, BC12, BC18, BC19	BC1, BC4, BC6, BC8, BC13, BC14, BC15, BC16, BC20, BC21		
Return Loss (dB)	~-12.4	~-14.0	~-13.0	~-16.2
VSWR	~2.1:1	~1.6:1	~1.7:1	~1.5:1
Efficiency (%)	~52.0	~44.7	~30.7	~27.0
Peak Gain (dBi)	~3.3	~2.0	~0.5	~0.6
Average Gain (dBi)	~-2.9	~-3.6	~-5.2	~-5.7
Impedance (Ohms)	50			
Polarisation	Linear			
Radiation Pattern	Omni-directional			
Max I/P Power (W)	25			
Connector Type	SMA male standard (other connectors available)			
Cable Length	3 meters standard (other lengths available)			
Cable Type	LMR100 (other cables available)			

Measurement Conditions:

- Mounted on 30 x 30 x 0.25cm ABS plate
- 1 meter of LMR100 cable
- Measured in certified CTIA 3D Anechoic chamber

1. Antenna and Electrical Specifications

Active Parameters	GNSS antenna	
Standards	GPS/QZSS/Galileo	GLONASS
Band (MHz)	1575	1602
Frequency (MHz)	1575.42	1598 - 1606
Patch Size (mm)	25 x 25 x 4	
Return Loss (dB)	≤-15	
VSWR	≤1.4:1	
Impedance (Ohms)	50	
Polarization	RHCP	
SAW Filter	Pre filter	
Radiation Pattern	Hemispherical	
Active Gain (dB)	28 @ 2.7V	
Noise Figure (dB)	1.5 typ.	
Voltage (V)	1.5 – 3.6	
Current (mA)	9 typ.	
Power Consumption (mW)	24.3 max	
ESD Protection (kV)	2	
Connector Type	SMA male standard (other connectors available)	
Cable Length	3 meters standard (other lengths available)	
Cable Type	LMR100 standard (other cables available)	

2. Mechanical and Environmental Specifications

Mounting Type	Adhesive mount
Dimensions (mm)	83 x 35 x 13.3
Radome	ABS UV stable
Radome Color	Black
Operating Temperature (°C)	-40 to +85
Storage Temperature (°C)	-40 to +85
Substance Compliance	RoHS, REACH
Certificates	IP67, IP69

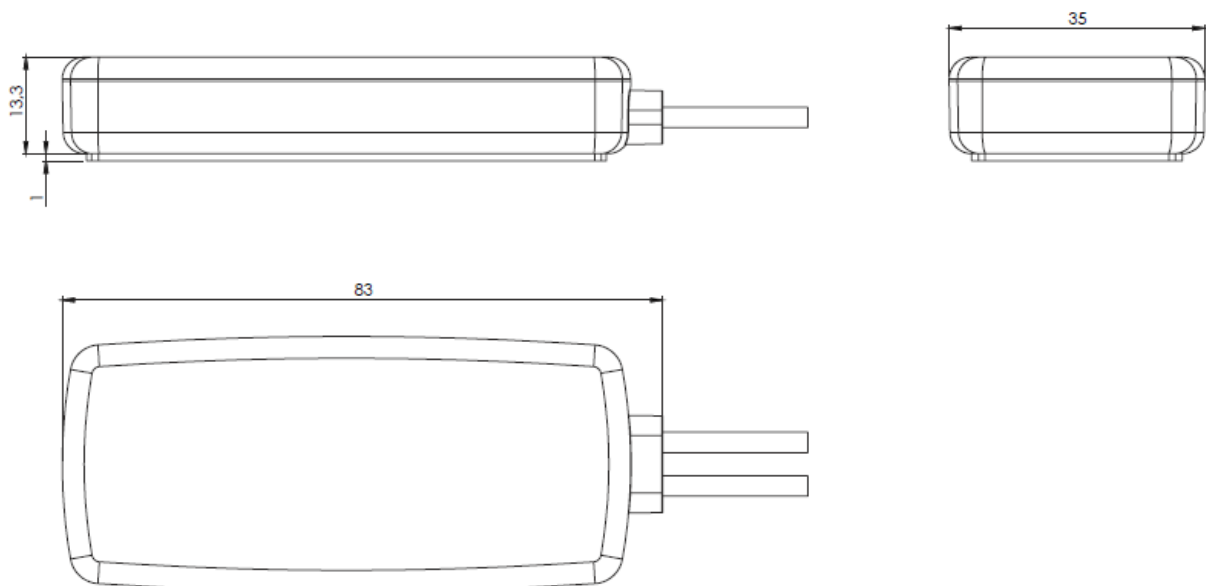

3. Antenna Parameters

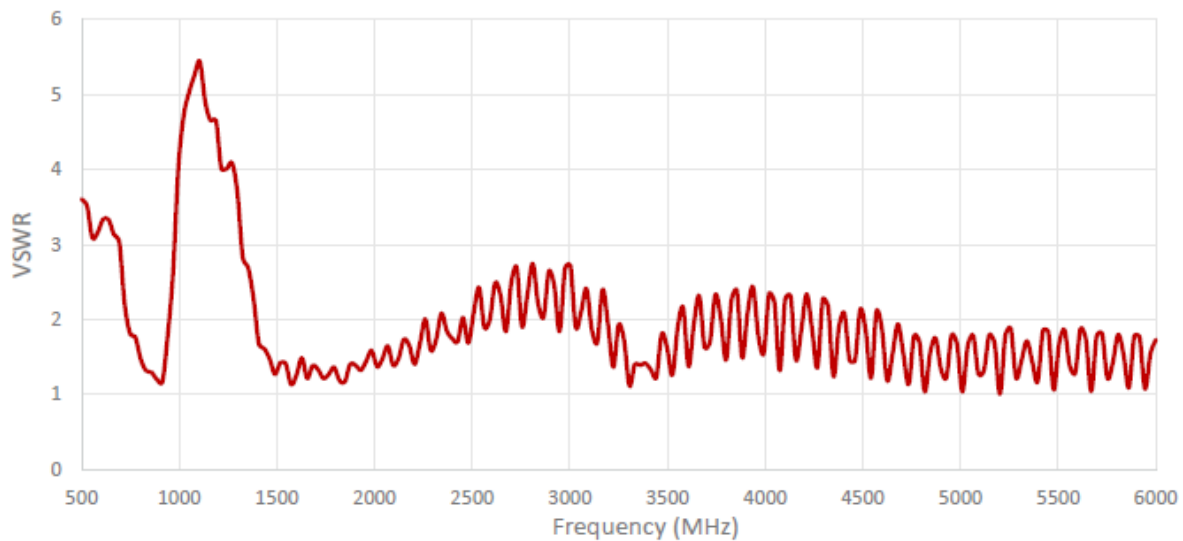
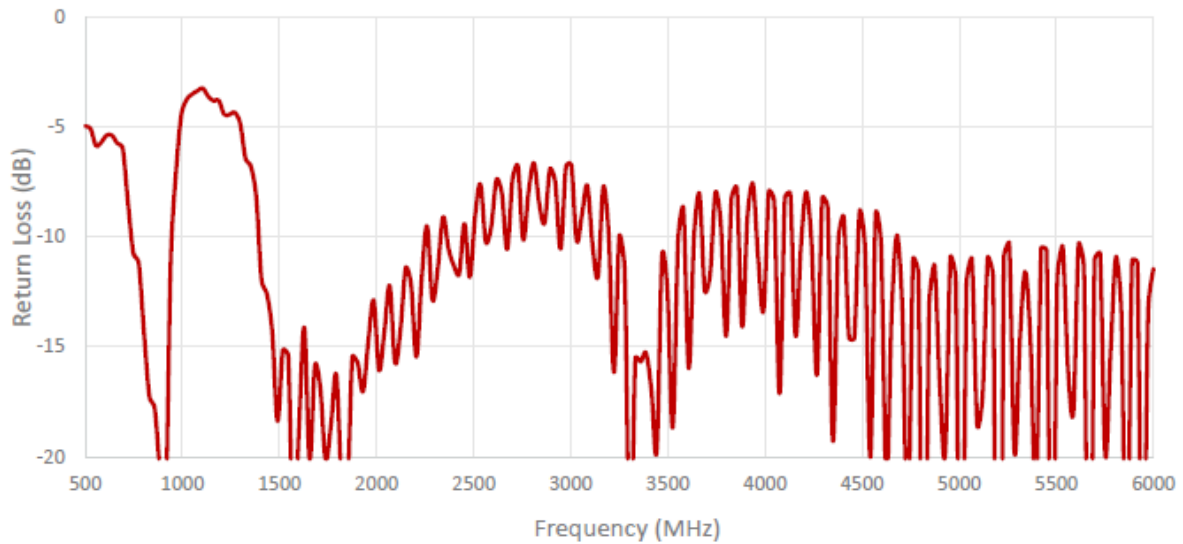

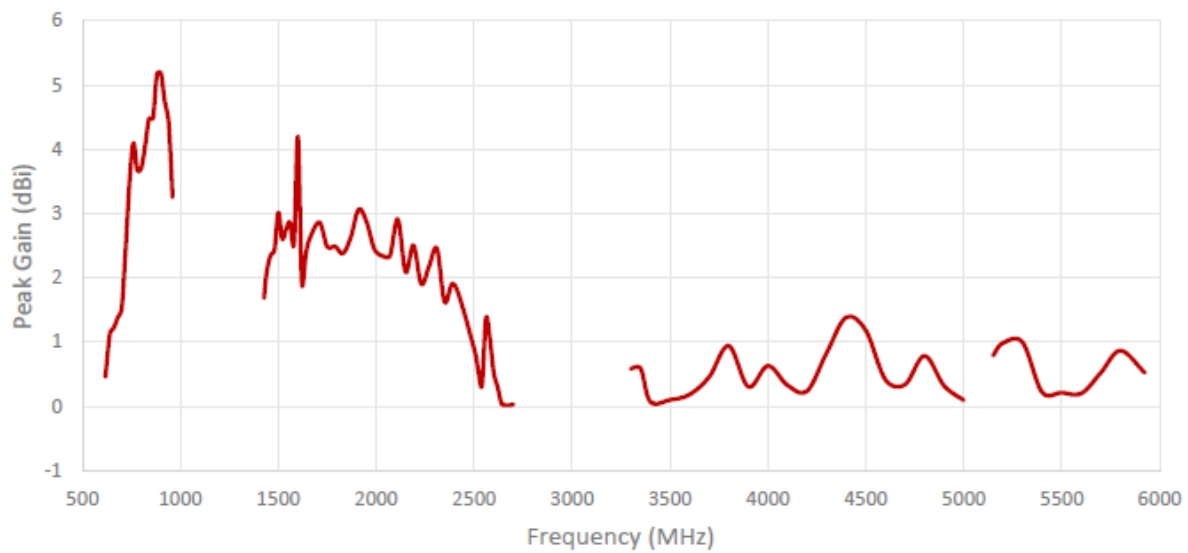
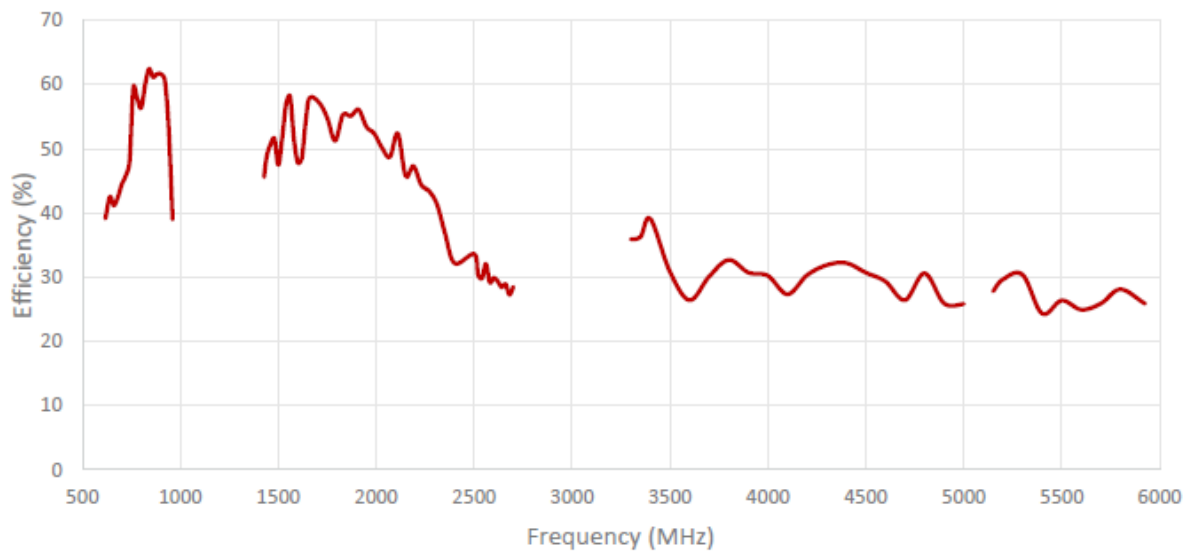

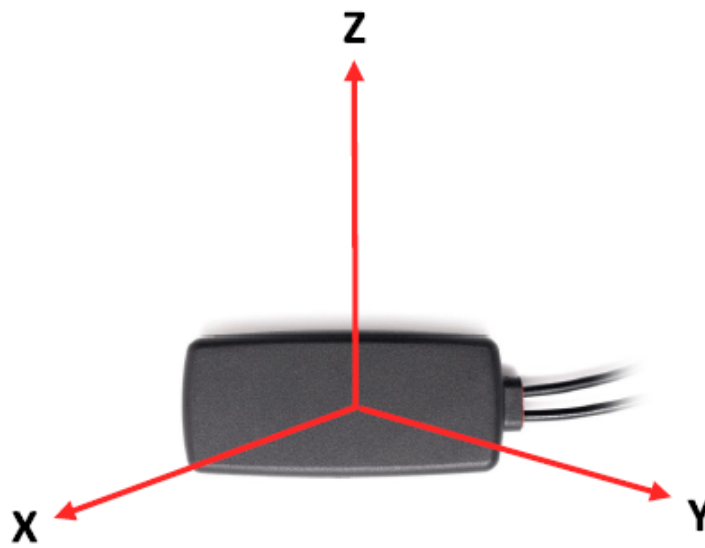
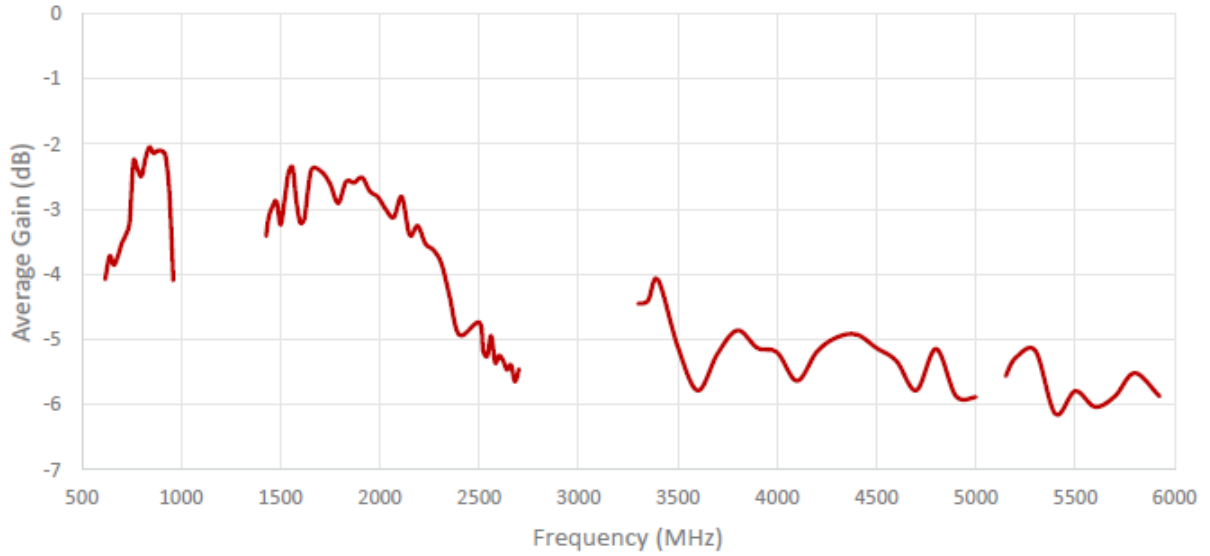

Radiation pattern reference

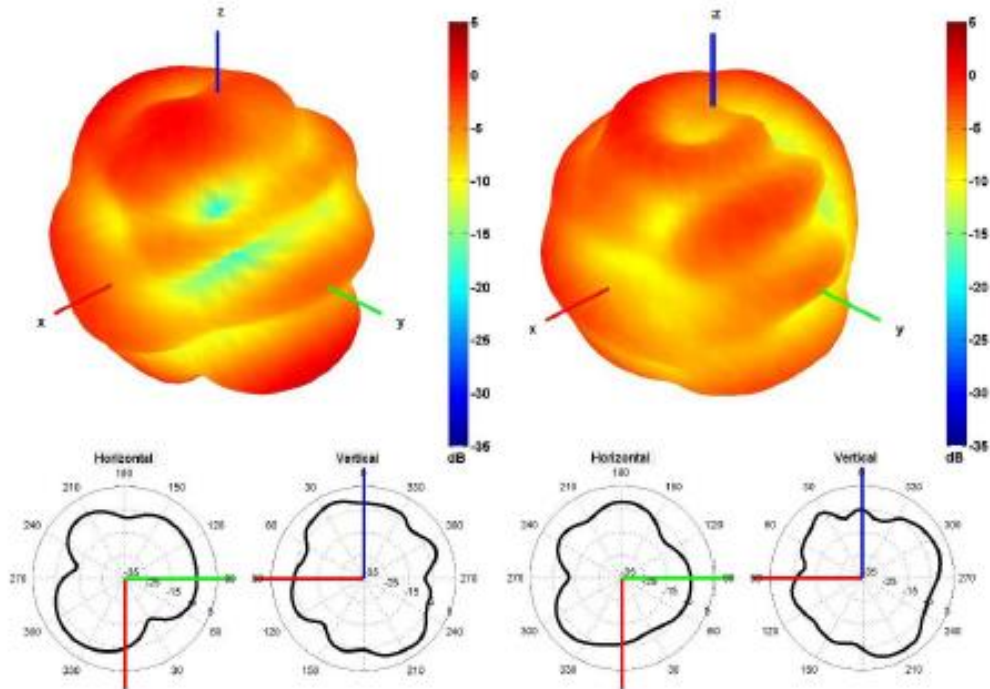

650 and 750 MHz Radiation pattern

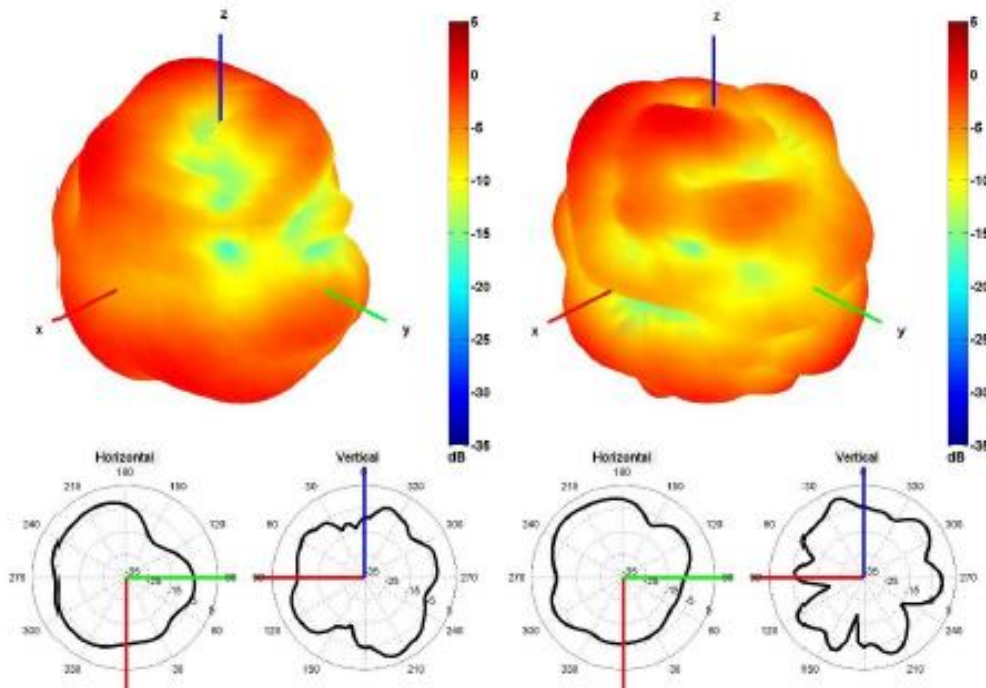

850 and 940 MHz Radiation pattern

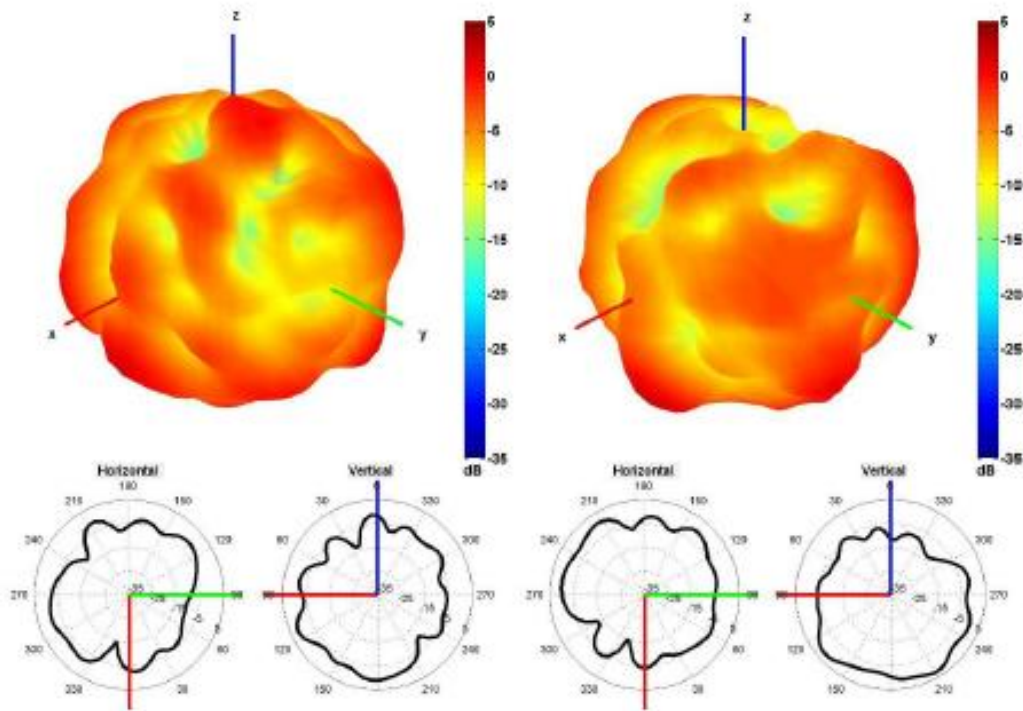

1500 and 1600 MHz Radiation pattern

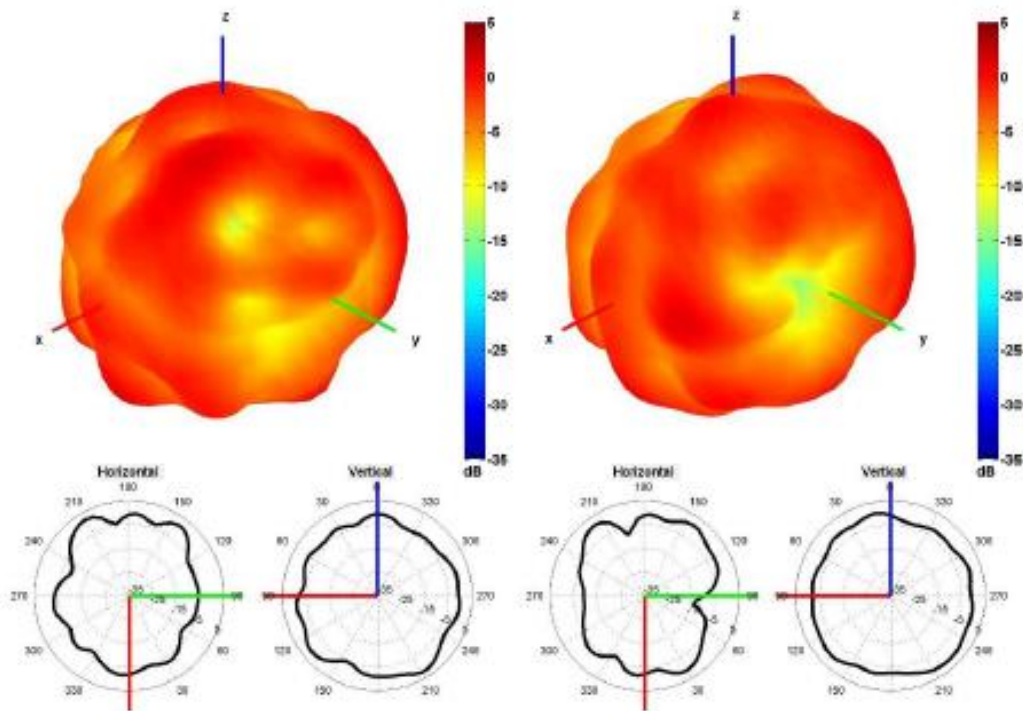

1750 and 1850 MHz Radiation pattern

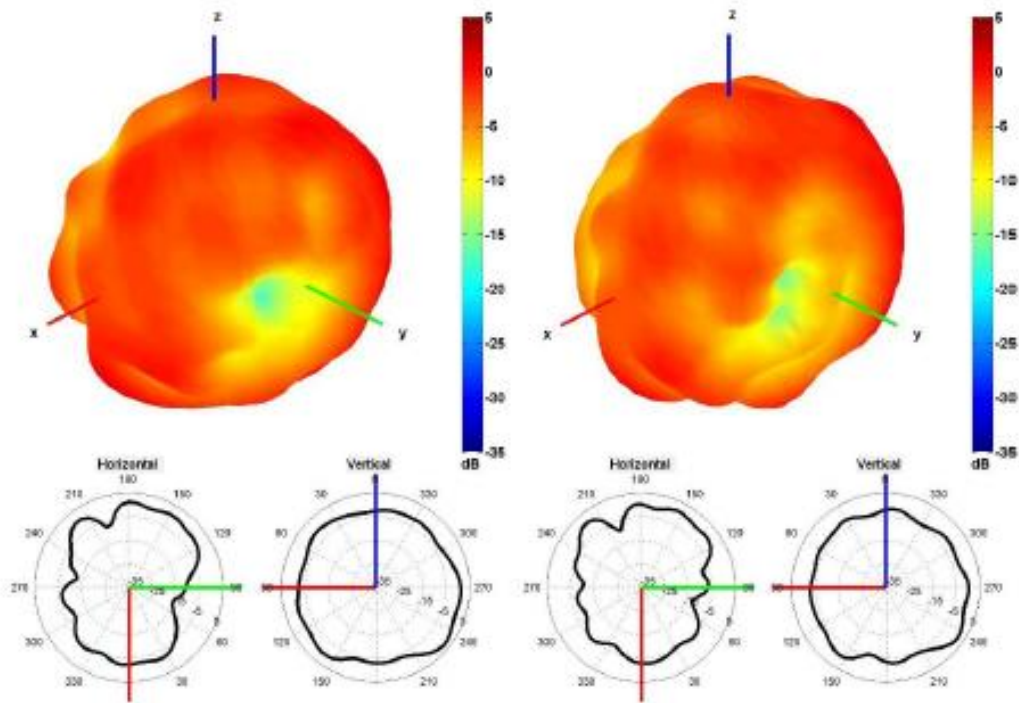

1950 and 2100 MHz Radiation pattern

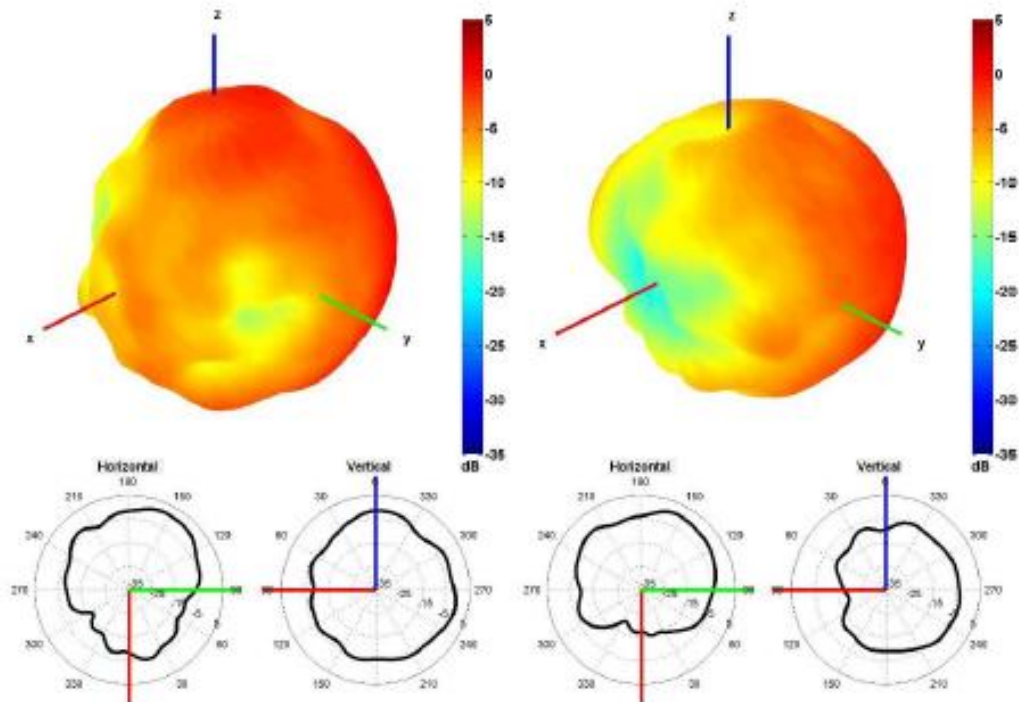

2350 and 2600 MHz Radiation pattern

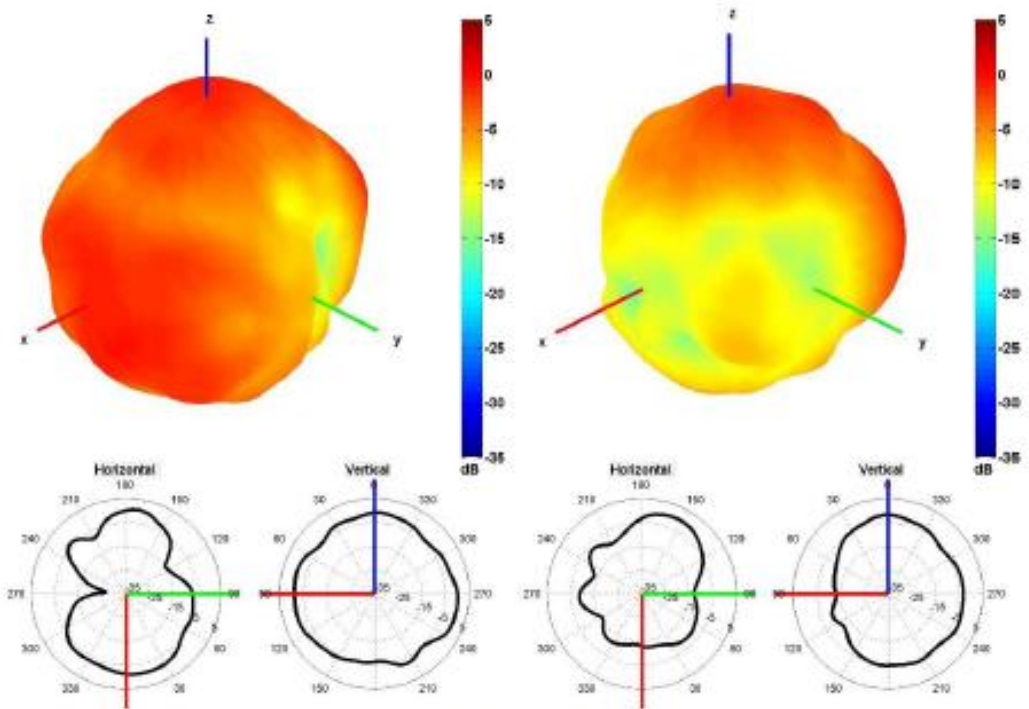

3350 and 3600 MHz Radiation pattern

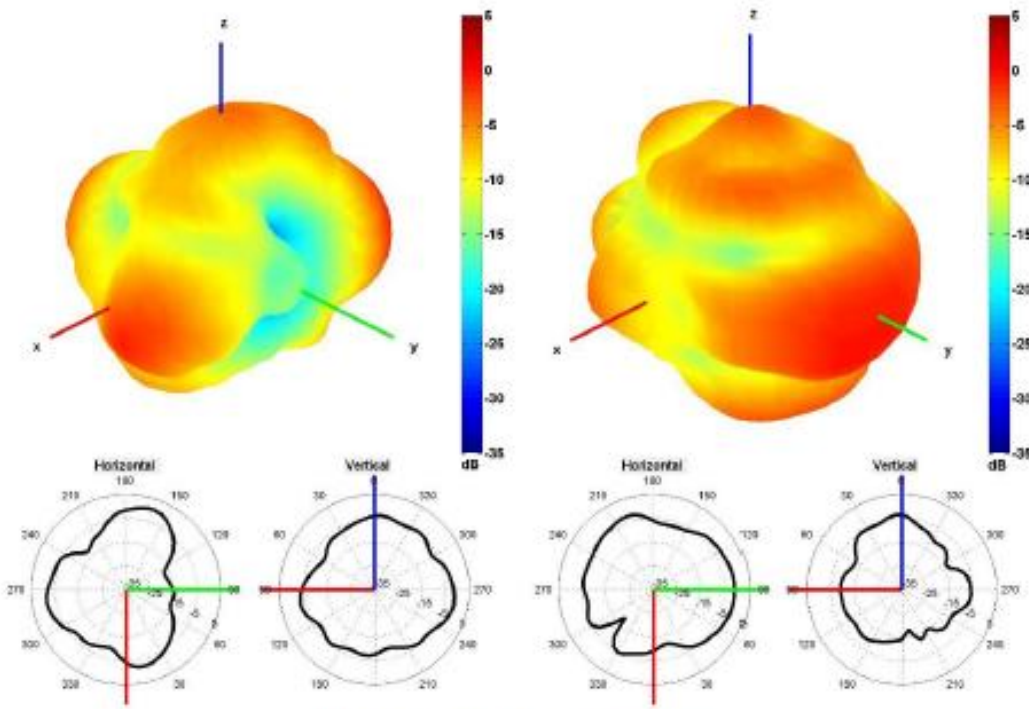

4500 and 5500 MHz Radiation pattern