

2JW0924-C952B
(Alpha Micro Part No. AMC2JW0924-C952B)
Cellular/LTE connector mount antenna

Features

- Cellular/LTE:
 - 698 – 960MHz
 - 1710 – 2170MHz
 - 2500 – 2700MHz
- Connector mount
- Ultra wide band antenna
- High performance
- Ground plane independent
- Hinged connector
- Dimensions: 170 x 18 x 10mm



1. Antenna and Electrical Specifications

Parameters	Cellular/LTE antenna		
Standards	2G/3G/4G		
Band (MHz)	700/850/900	1700/1800/1900/2100	2600
Frequency (MHz)	698 - 960	1710 - 2170	2500 - 2700
Return loss (dB)	~-12.6	~-14.8	~-16.8
VSWR	~1.7:1	~1.5:1	~1.3:1
Efficiency (%)	~54	~60	~67
Peak gain (dBi)	~-0.6	~2.6	~2.3
Average gain (dB)	~-2.7	~-2.1	~-1.7
Impedance (Ohms)	50		
Polarization	Linear		
Radiation pattern	Omni-Directional		
Max. input power (W)	25		
Connector type	SMA male standard		

Measurement Conditions:

- Free space
- Measured in certified CTIA 3D Anechoic chamber

2. Mechanical and Environmental Specifications

Mounting type	Connector mount
Dimensions (mm)	170 x 18 x 10
Radome type	PC/ABS UV stable
Radome color	Black
Connector feature	Hinged
Operating temperature (°C)	-40 to +85
Storage temperature (°C)	-40 to +85
Substance compliance	RoHS

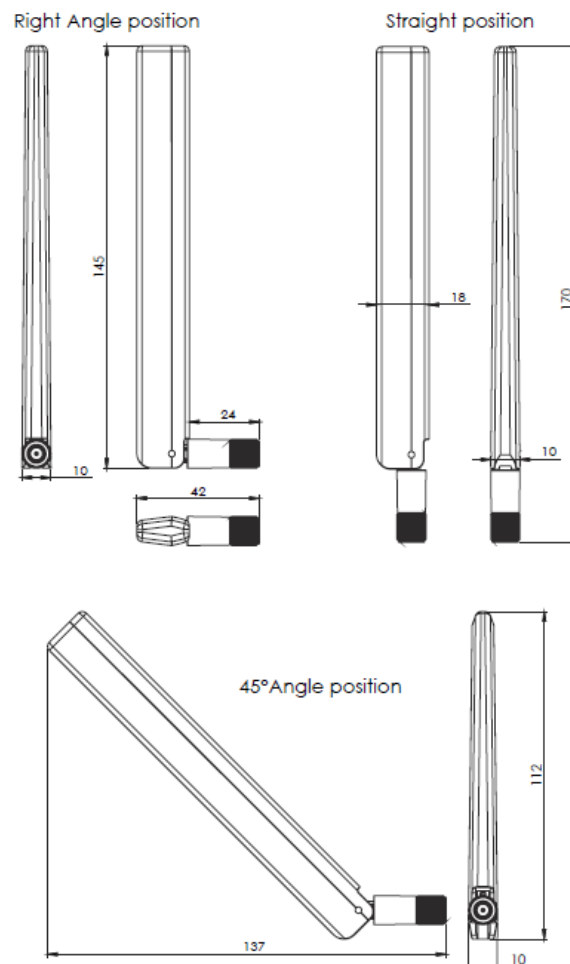

3. Antenna Parameters

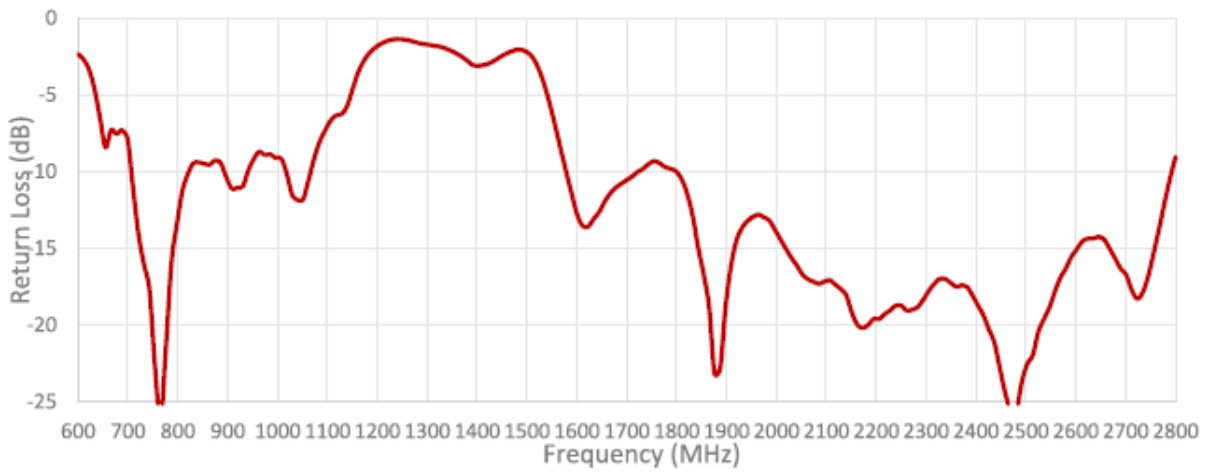

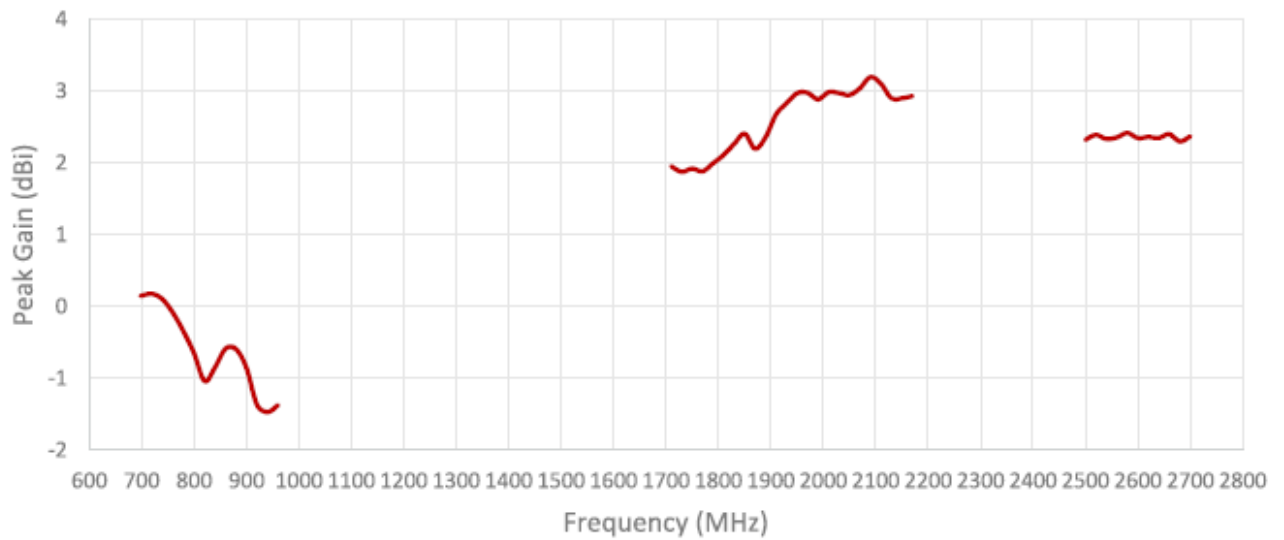
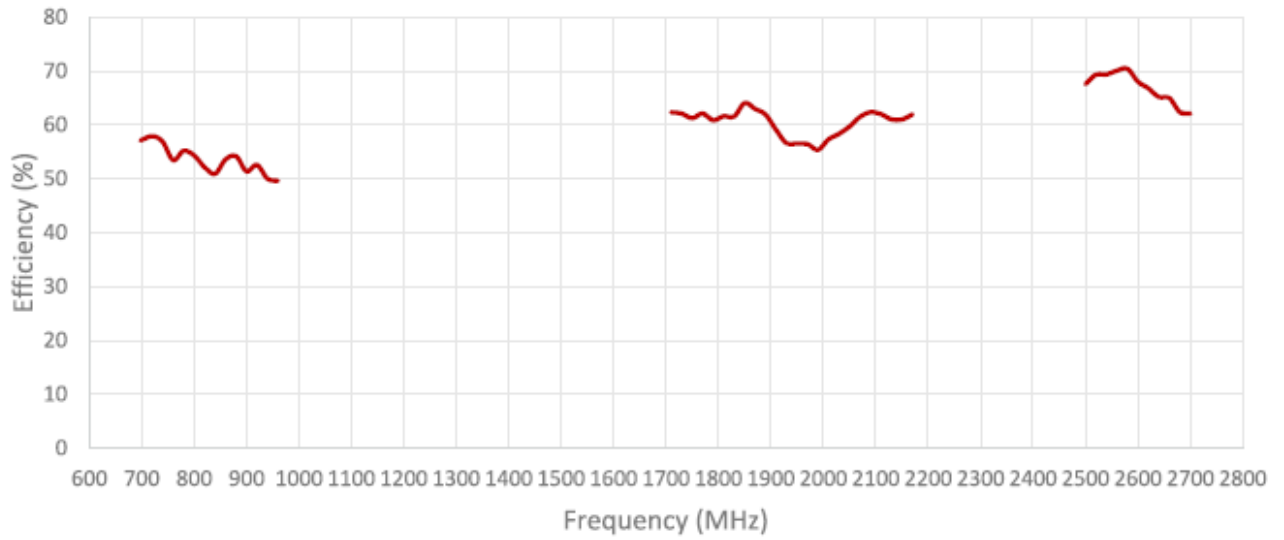

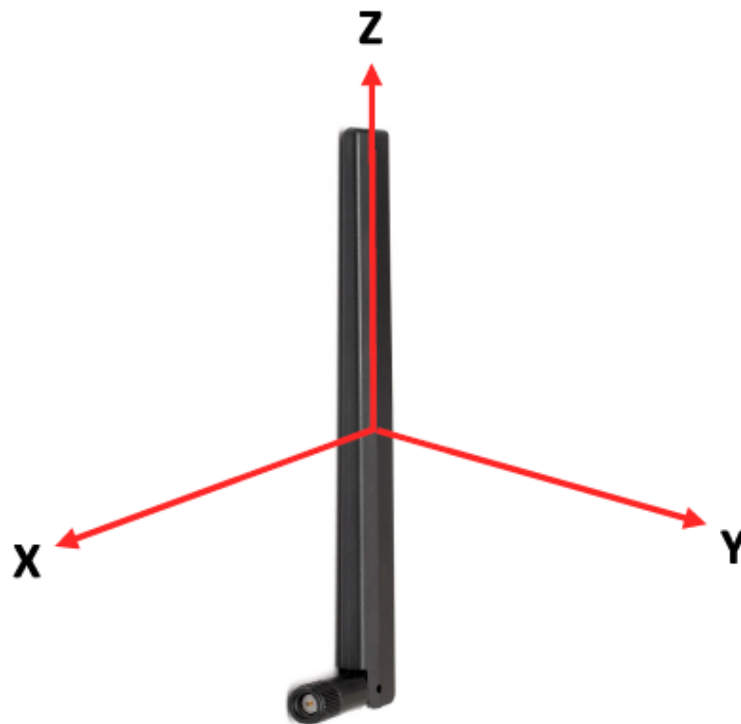
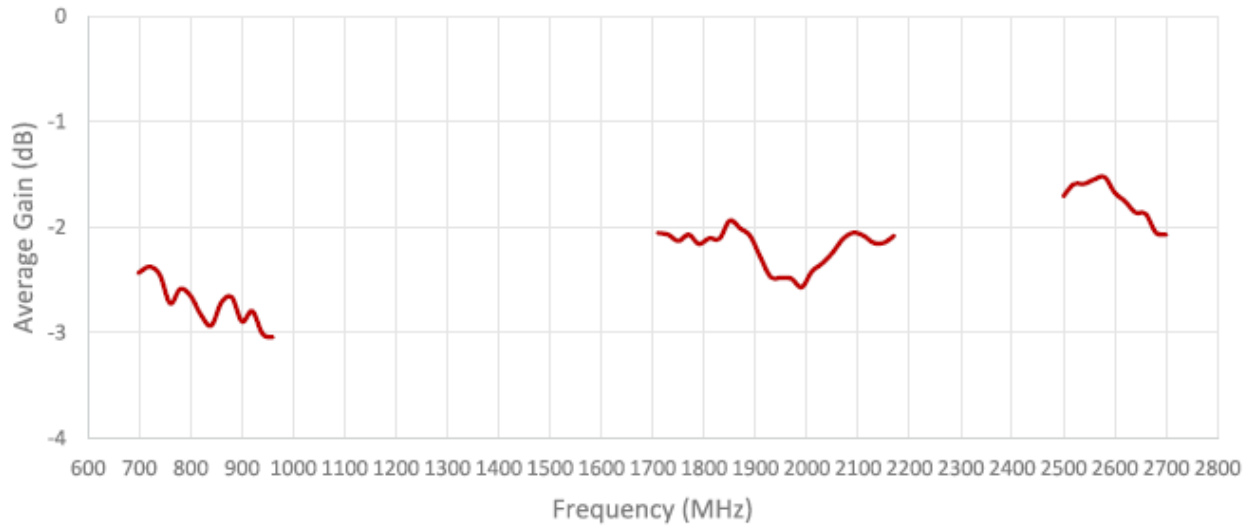

Radiation pattern reference

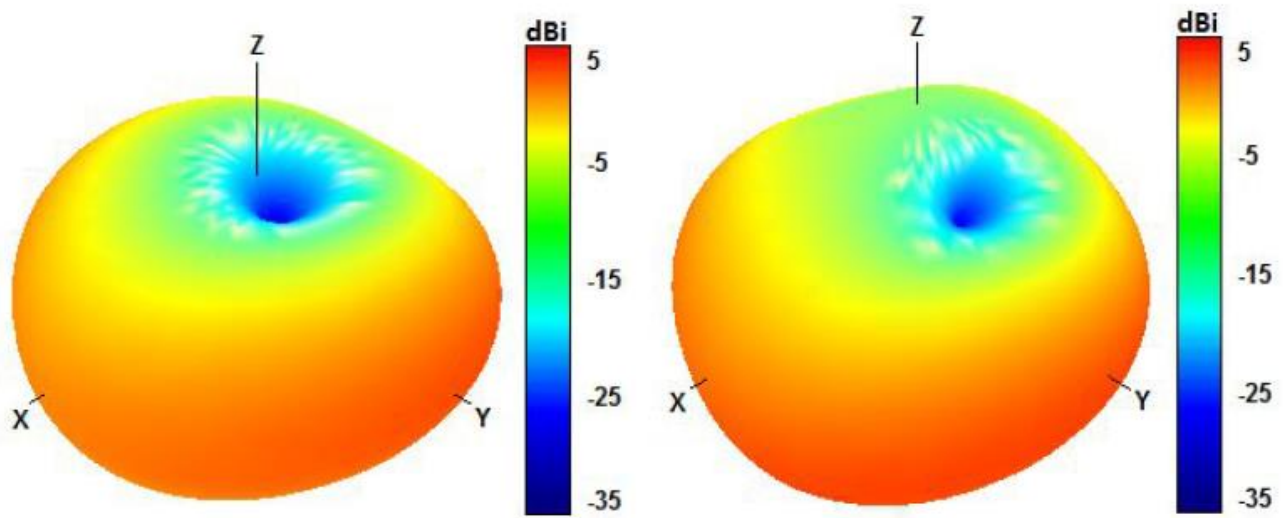

750 and 850 MHz Radiation pattern

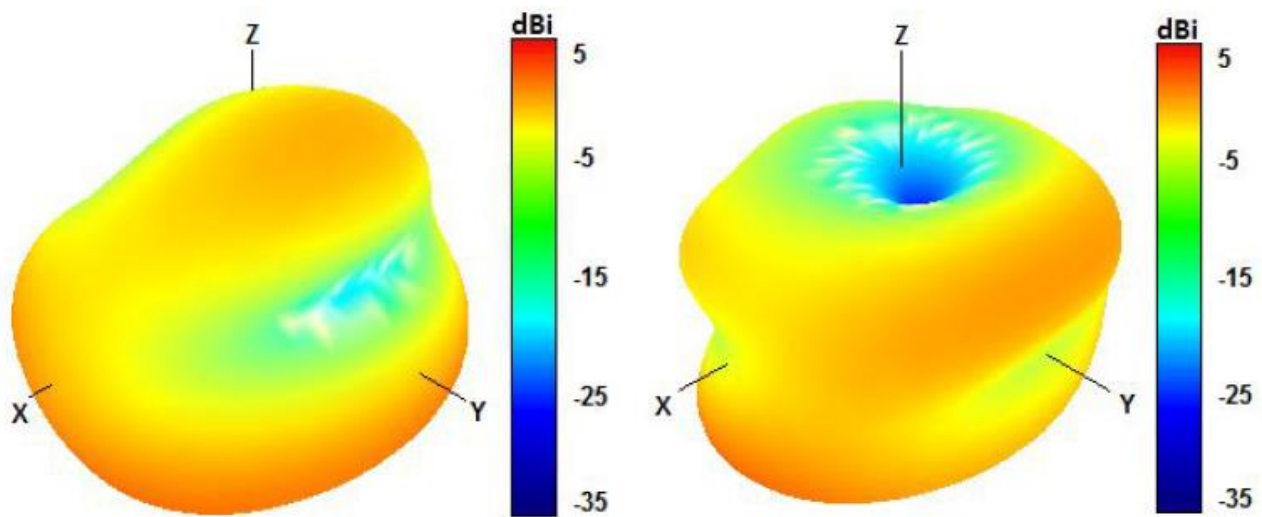

940 and 1750 MHz Radiation pattern

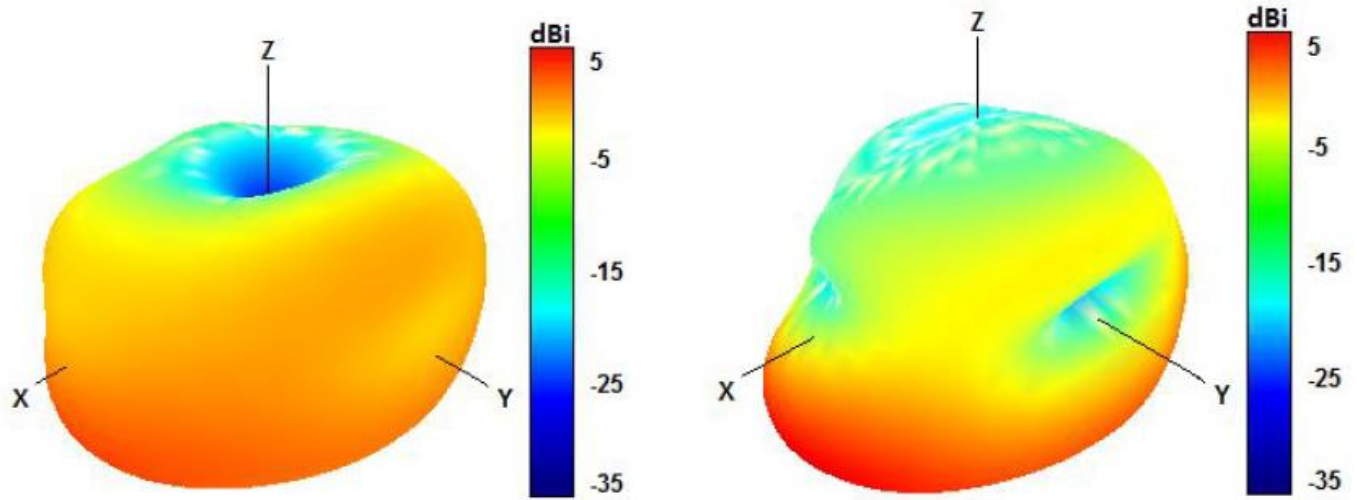

1850 and 1950 MHz Radiation pattern

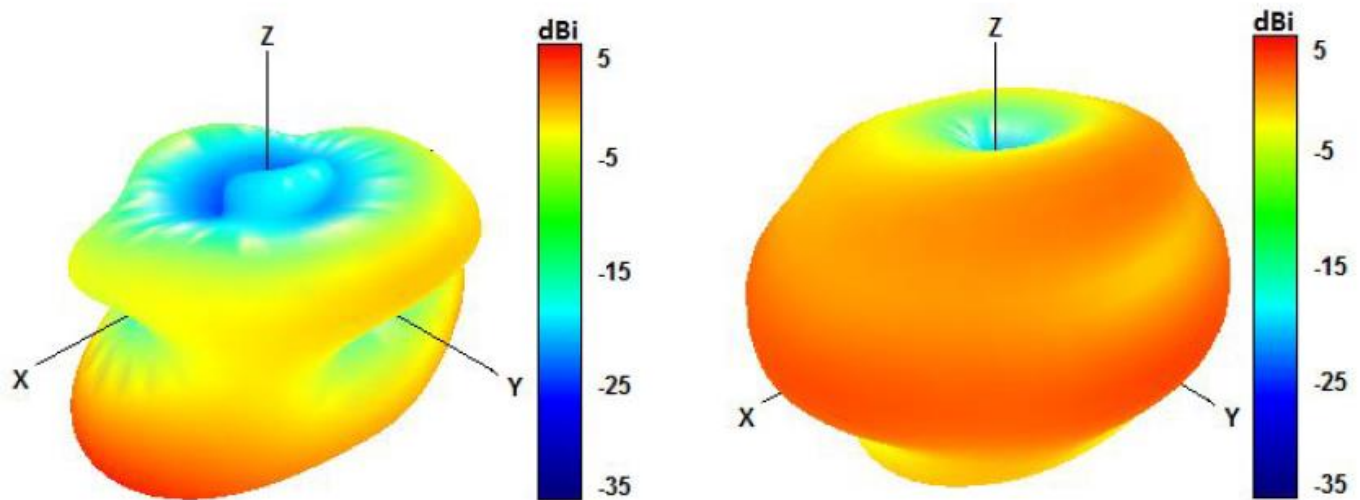

2100 and 2600 MHz Radiation pattern