

2JW0302-2.4
(Alpha Micro Part No. AMC2JW0302-2.4)

2.4GHz ISM connector mount antenna

Features

- 2.4GHz ISM
 - 2410 - 2490MHz
- Connector mount
- Ground plane independent
- High efficiency
- Hinged connector
- Dimensions – Ø 10 x 113mm



Certifications:



Alpha Micro USA: Tel: +1 561 744 9986 | email: usasales@alphamicro.net
www.alphamicro.net



1. Antenna and Electrical Specifications

Parameters	2.4GHz ISM Antenna
Standards	Wi-Fi, Bluetooth, ZigBee, ISM
Band (MHz)	2400
Frequency (MHz)	2410 - 2490
Return Loss (dB)	~-10
VSWR	~1.9:1
Efficiency (%)	~62
Peak Gain (dBic)	~1.5
Average Gain (dB)	~-2.0
Impedance (Ohms)	50
Polarization	Vertical
Radiation Pattern	Omni-directional
Max. Input Power (W)	25
Connector Type	RP-SMA male standard

Measurement Conditions:

- Free space
- Measured in certified CTIA 3D anechoic chamber

2. Mechanical and Environmental Specifications

Mounting Type	Connector mount
Dimensions (mm)	113 x \varnothing 10
Radome	ABS UV Stable
Radome Color	Black
Operating Temperature (°C)	-40 to +85
Storage Temperature (°C)	-40 to +85
Substance Compliance	RoHS

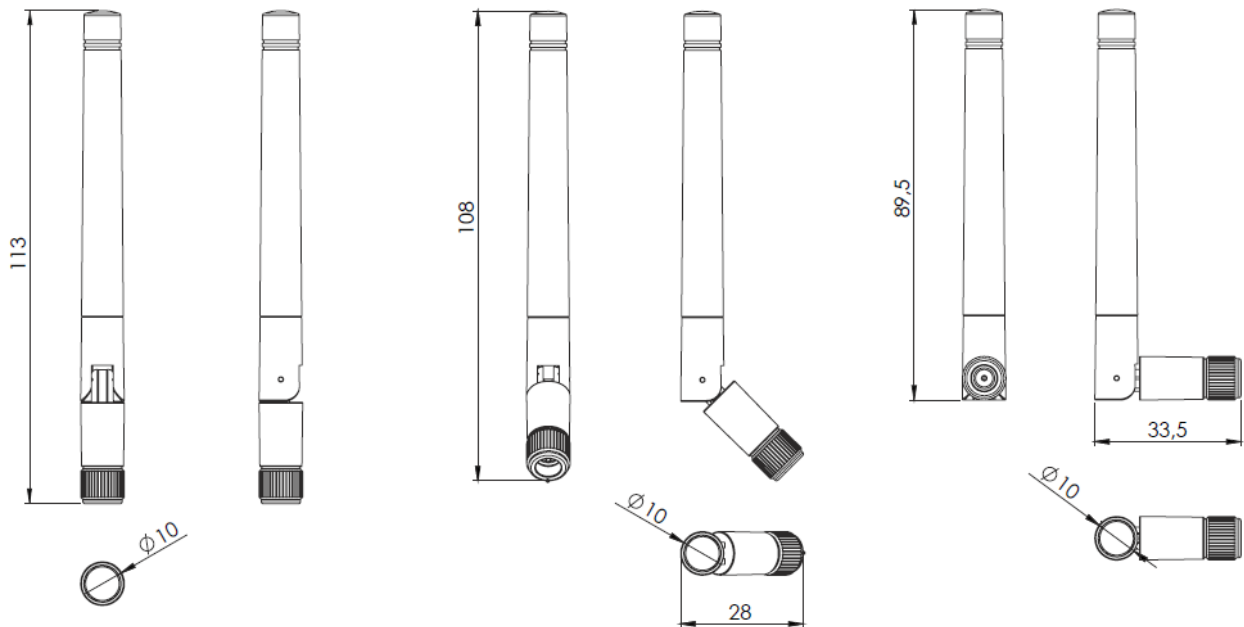

3. Antenna Parameters

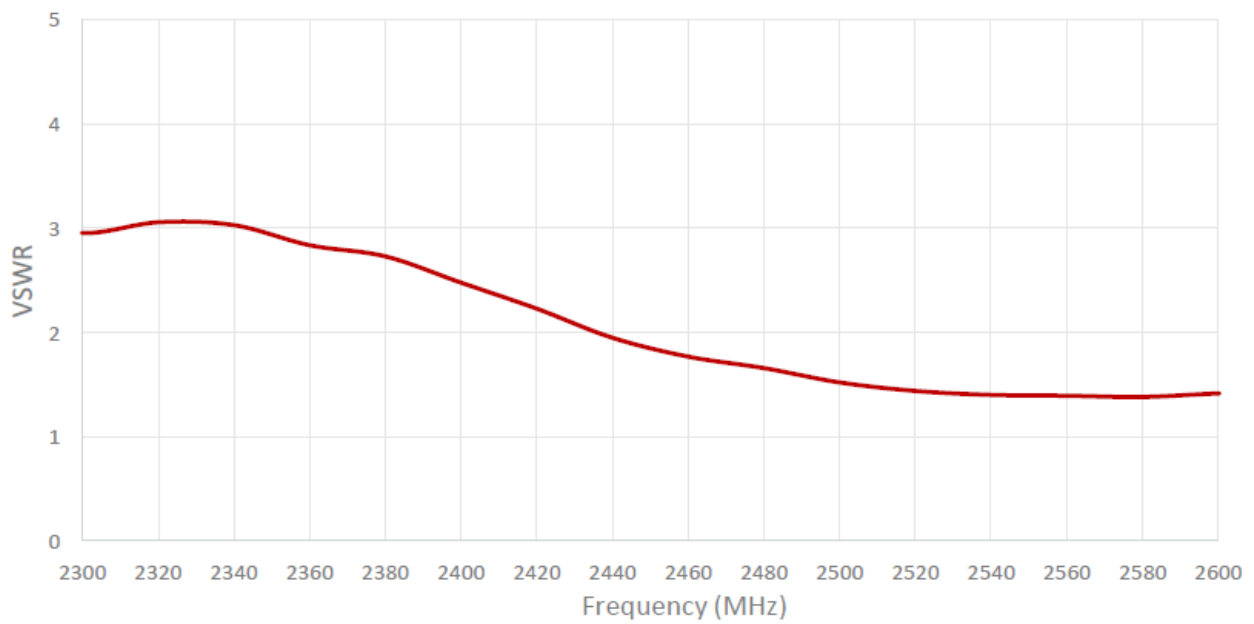
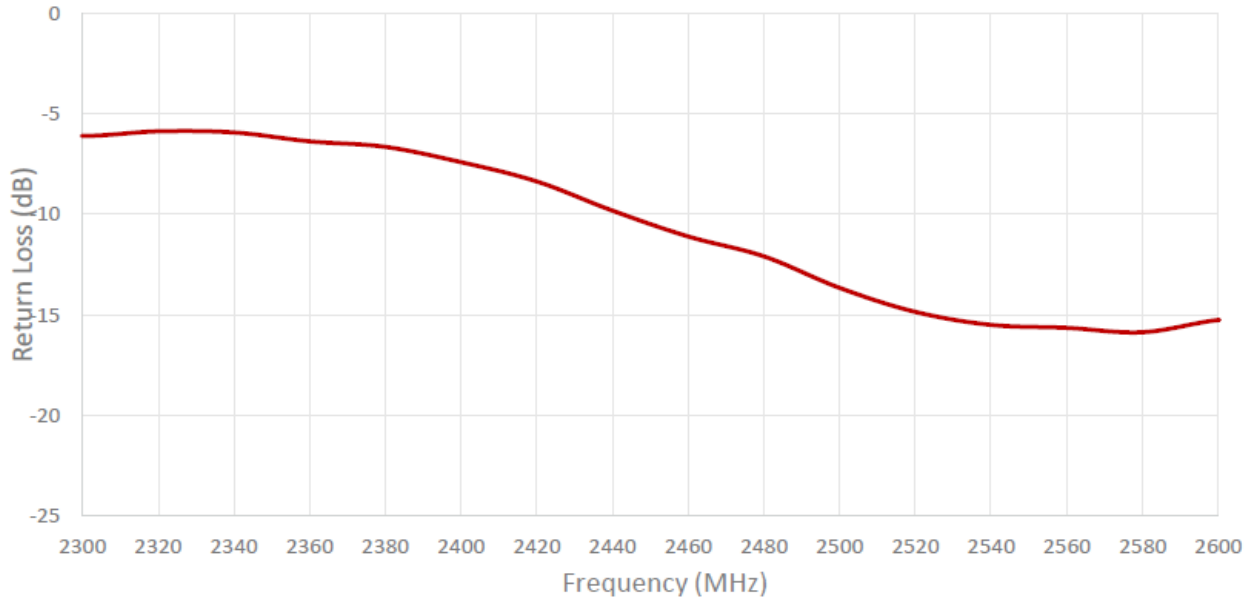

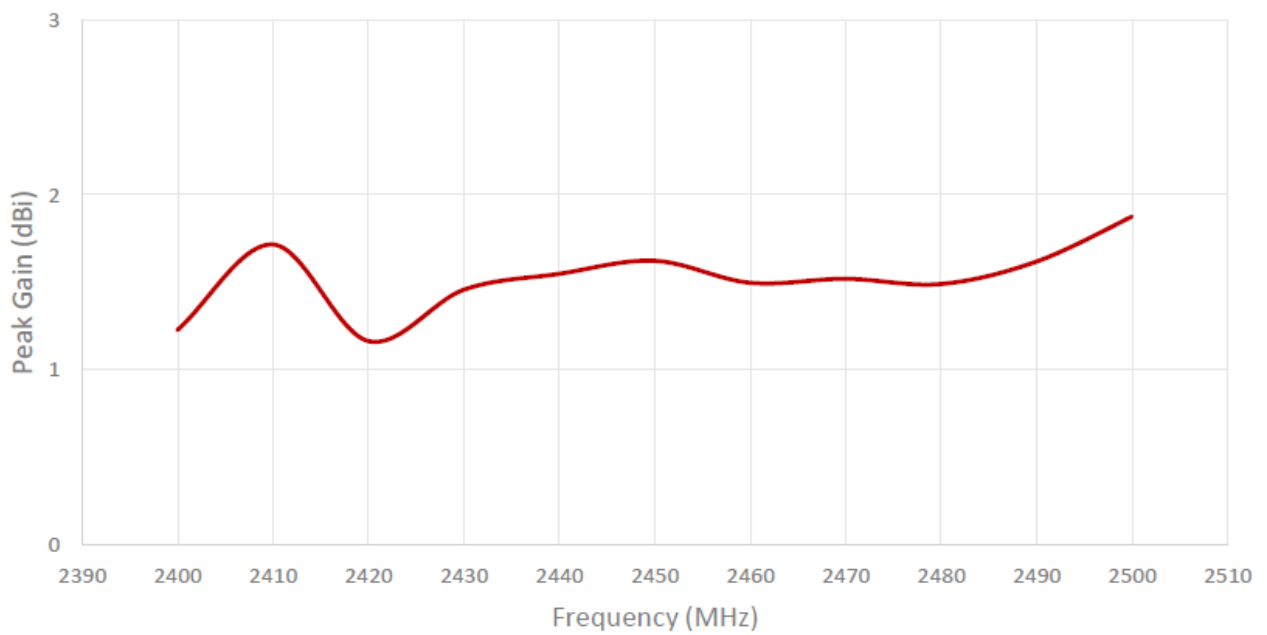
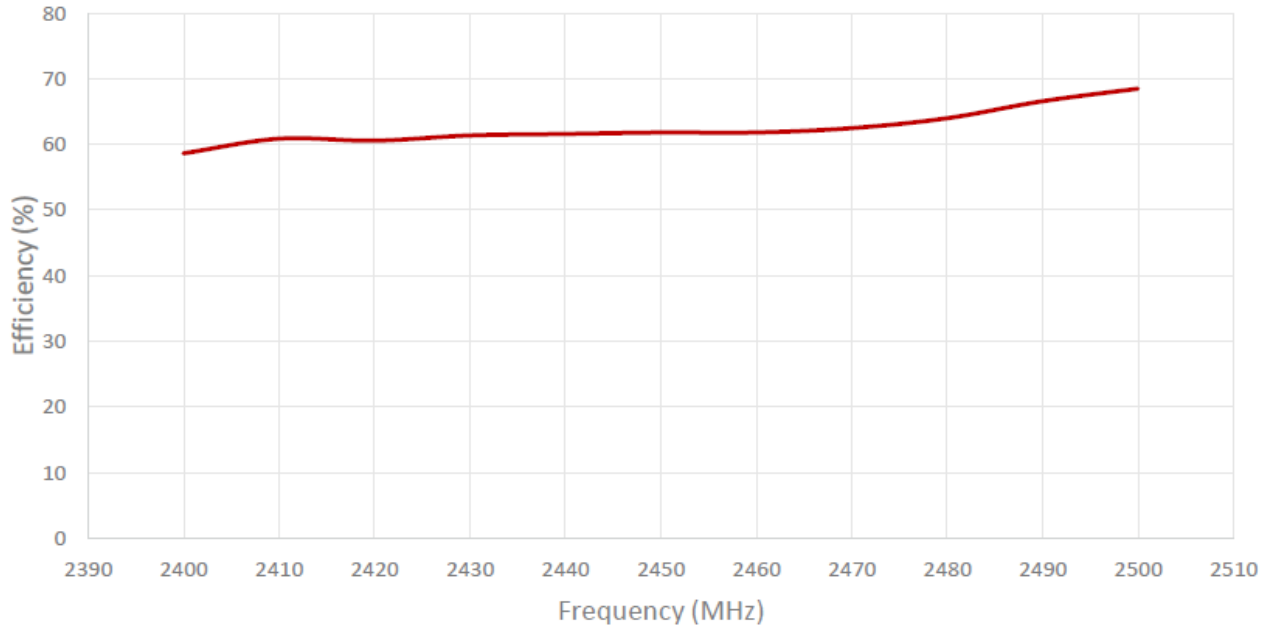

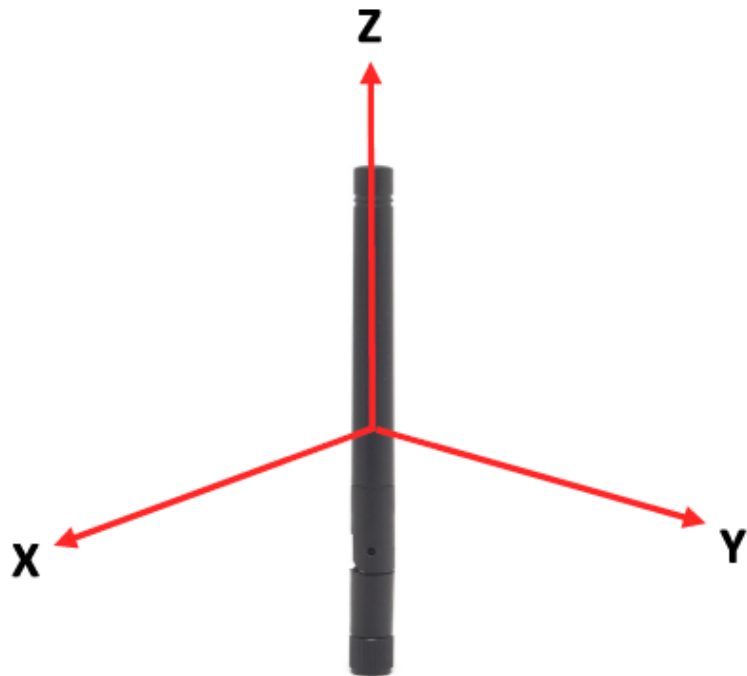
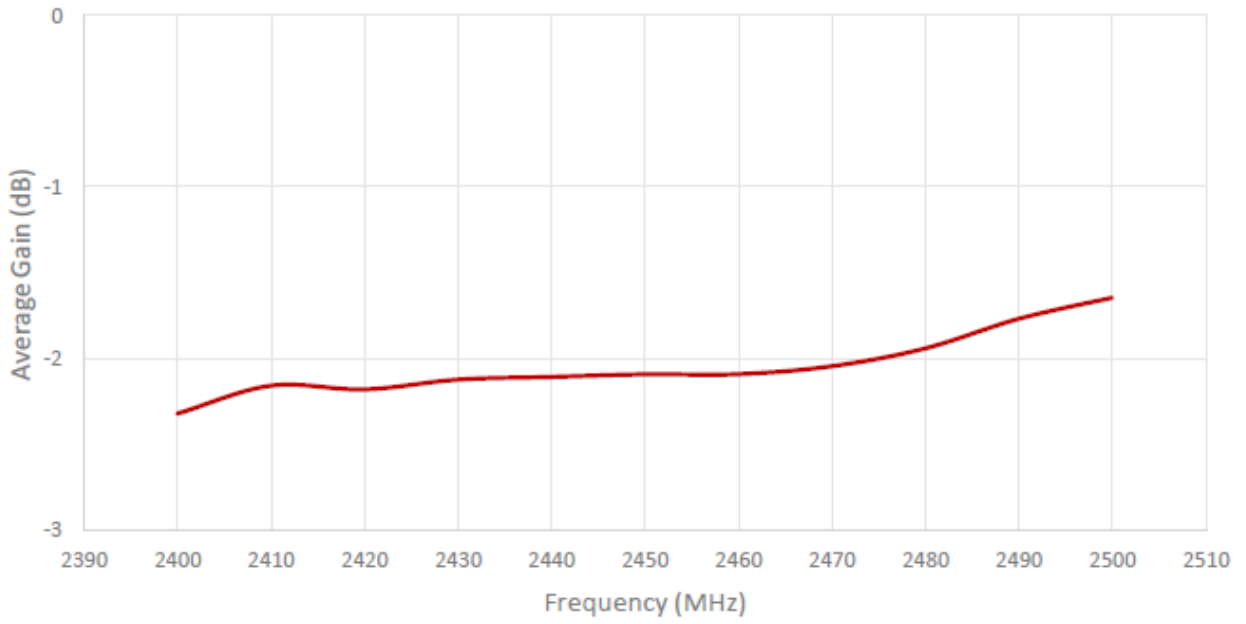

Radiation pattern reference

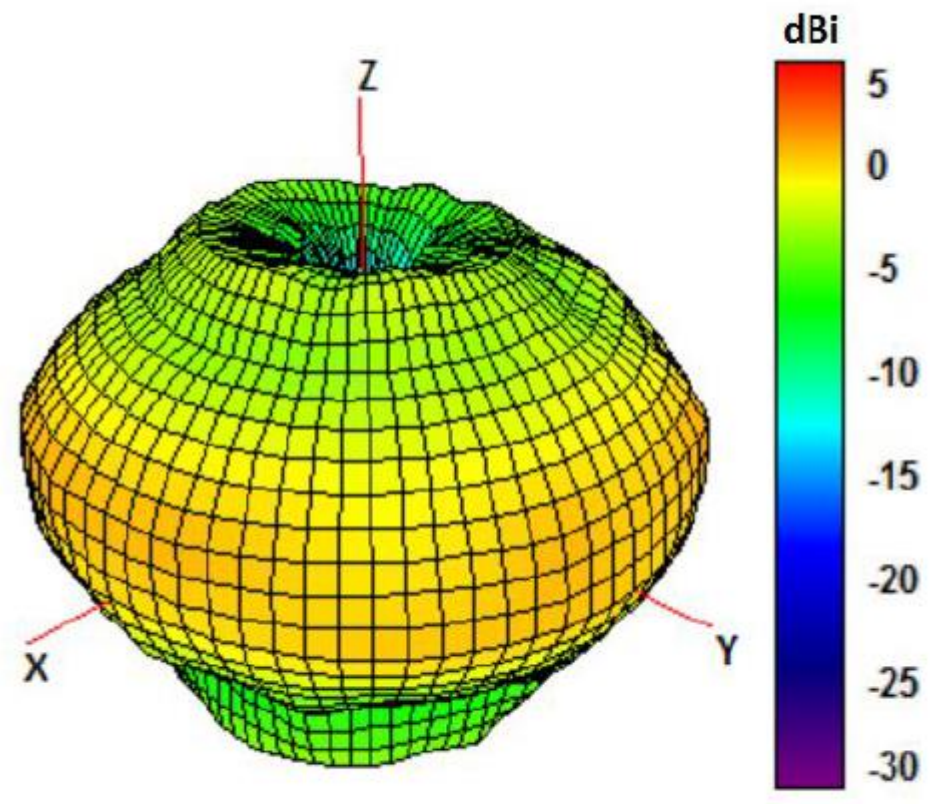

2450 MHz Radiation pattern